

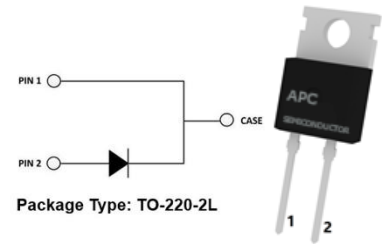

High Power SiC Schottky Barrier Diode ASA010V065A4



Applications:

- Industrial power supplies:
Industrial UPS
- Battery chargers
- Solar inverters
- Switch mode power supplies

Features:

- Revolutionary semiconductor material - Silicon Carbide (SiC)
- No reverse recovery
- High-speed switching performance
- System cost / size saving due to reduced cooling requirement
- Junction Temp range -55°C to 175°C

Absolute Maximum Ratings ($T_{amb}=25^{\circ}\text{C}$, unless specified otherwise)

Symbol	Parameter		ASA010V065A4	Unit
V_{DC}	DC reverse voltage		650	V
V_{RRM}	Repetitive peak reverse voltage			
V_{RSM}	Surge peak reverse voltage			
I_F	Continuous Forward Current		$T_C = 25^{\circ}\text{C}$	30
			$T_C = 135^{\circ}\text{C}$	15
			$T_C = 155^{\circ}\text{C}$	10
I_{FSM}	Surge non-repetitive forward current	$T_C = 25^{\circ}\text{C}$, $t_p = 10\text{ms}$, half sine pulse	68	A
		$T_C = 150^{\circ}\text{C}$, $t_p = 10\text{ms}$, half sine pulse	55	
$I_{F,Max}$	Non-repetitive peak forward current	$T_C = 25^{\circ}\text{C}$, $t_p = 10\mu\text{s}$, pulse	563	
I_{FRM}	Surge repetitive forward current	$T_C = 25^{\circ}\text{C}$, $t_p = 10\text{ms}$, half sine wave $D = 0.1$	48	
P_{tot}	Total Power Dissipation		115	W
$\int i^2 dt$	i^2t value		23	A^2s
T_j	Operating junction temperature range		-55 to 175	$^{\circ}\text{C}$
T_{stg}	Storage temperature range		-55 to 175	
M	Mounting torque	M3 screw	1	Nm

Static Electrical Characteristics ($T_A = 25^\circ\text{C}$, unless specified otherwise)

Symbol	Parameter	Test Conditions	Min	Typ	Max	Unit
V_{DC}	DC blocking voltage	$I_R = 100 \mu\text{A}$	650	-	-	V
V_F	Forward voltage	$I_F = 10\text{A}, T_j = 25^\circ\text{C}$	-	1.27	1.45	V
		$I_F = 10\text{A}, T_j = 175^\circ\text{C}$	-	1.45	1.70	
I_R	Reverse current	$V_R = 650\text{V}, T_j = 25^\circ\text{C}$	-	5	80	μA
		$V_R = 650\text{V}, T_j = 175^\circ\text{C}$	-	30	320	

Thermal Characteristics

Symbol	Parameter	Test conditions	Min	Typ	Max	Unit
$R_{\theta JC}$	Junction-to-case Thermal Resistance		-	1.30	-	$^\circ\text{C}/\text{W}$

Dynamic Characteristics ($T_A = 25^\circ\text{C}$, unless specified otherwise)

C	Total capacitance	$V_R = 0\text{V}, f = 1\text{MHz}$	-	629	-	pF
		$V_R = 200\text{V}, f = 1\text{MHz}$	-	41	-	
		$V_R = 400\text{V}, f = 1\text{MHz}$	-	32	-	
Q_C	Total capacitive charge	$V_R = 400\text{V}$	-	28	-	nC
E_C	Capacitance stored energy	$V_R = 400\text{V}$	-	4.10	-	μJ

Electrical Characteristic Diagrams

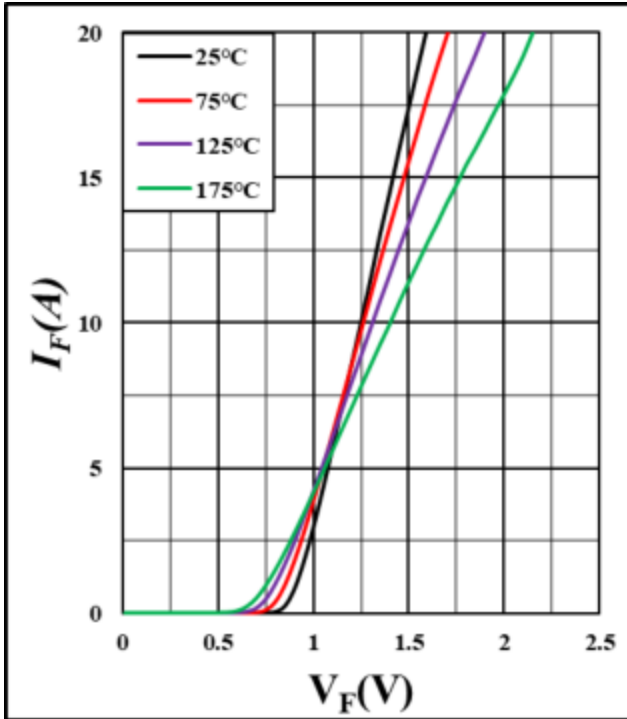

Figure 1. Forward characteristics

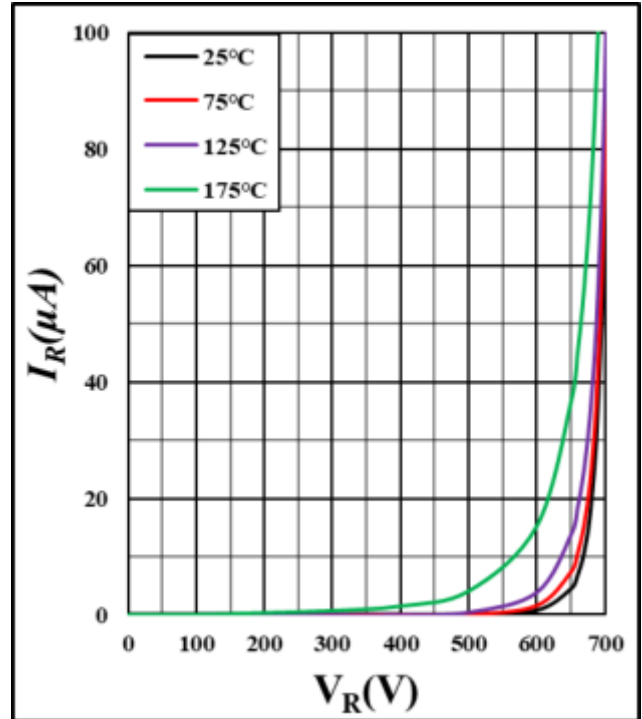

Figure 2. Reverse characteristics

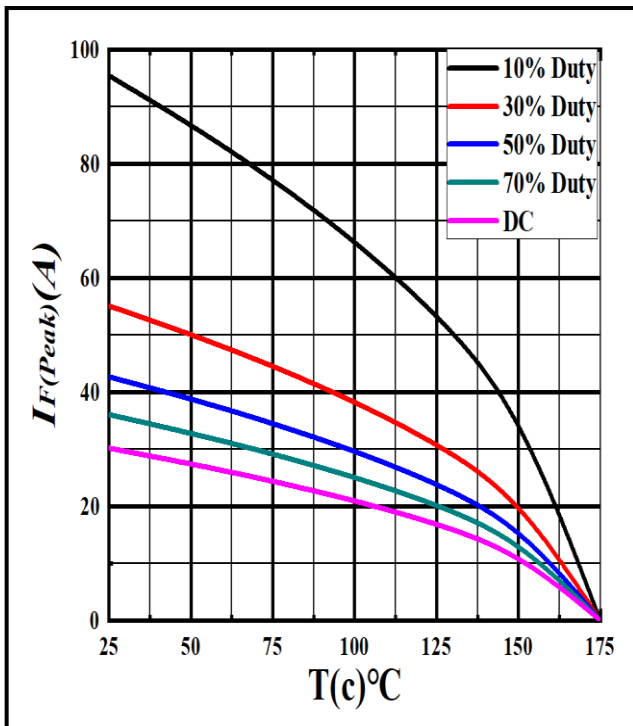

Figure 3. Current derating

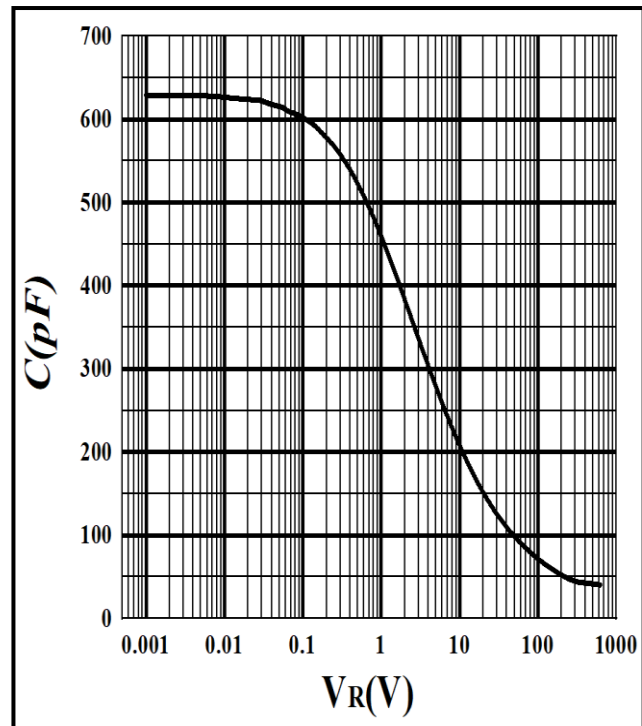

Figure 4. Capacitance vs. reverse voltage

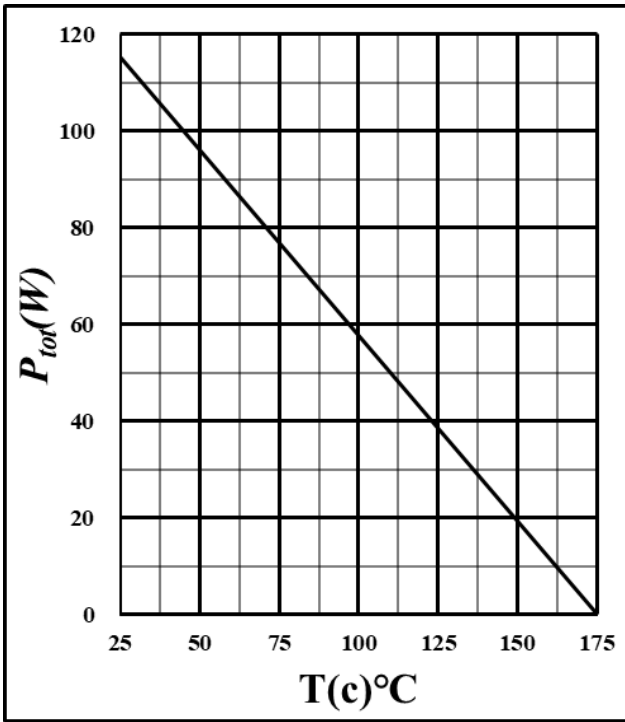

Figure 5. Power derating

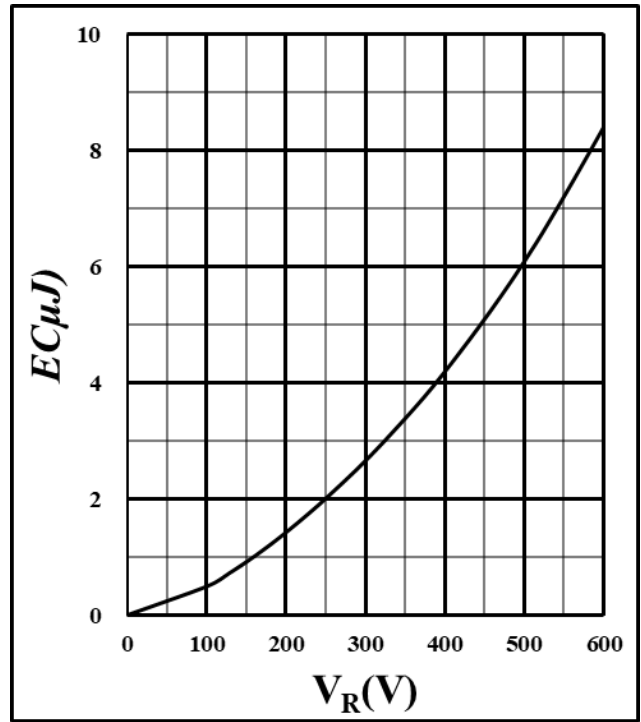

Figure 6. Capacitance stored energy

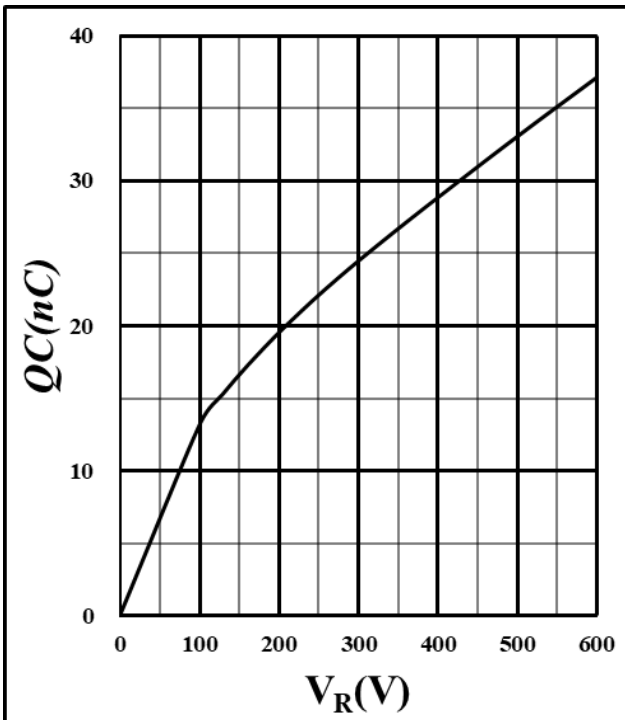

Figure 7. Total capacitance charge vs. reverse voltage

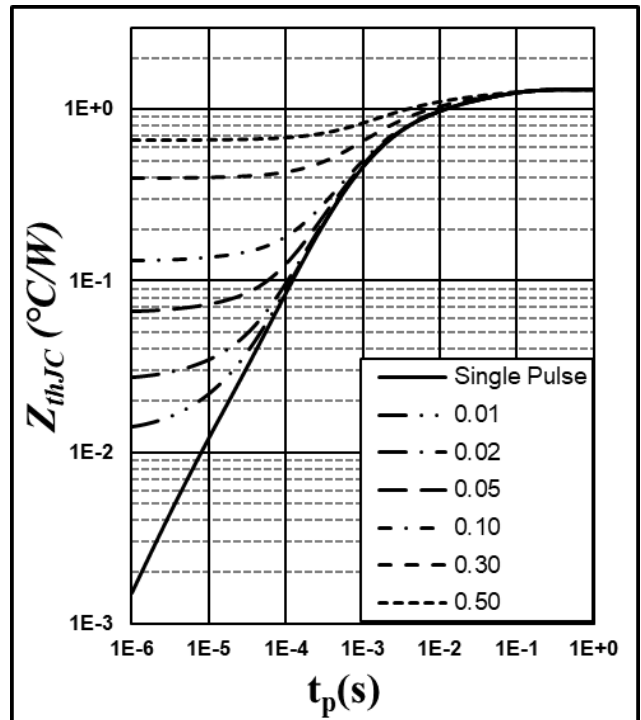
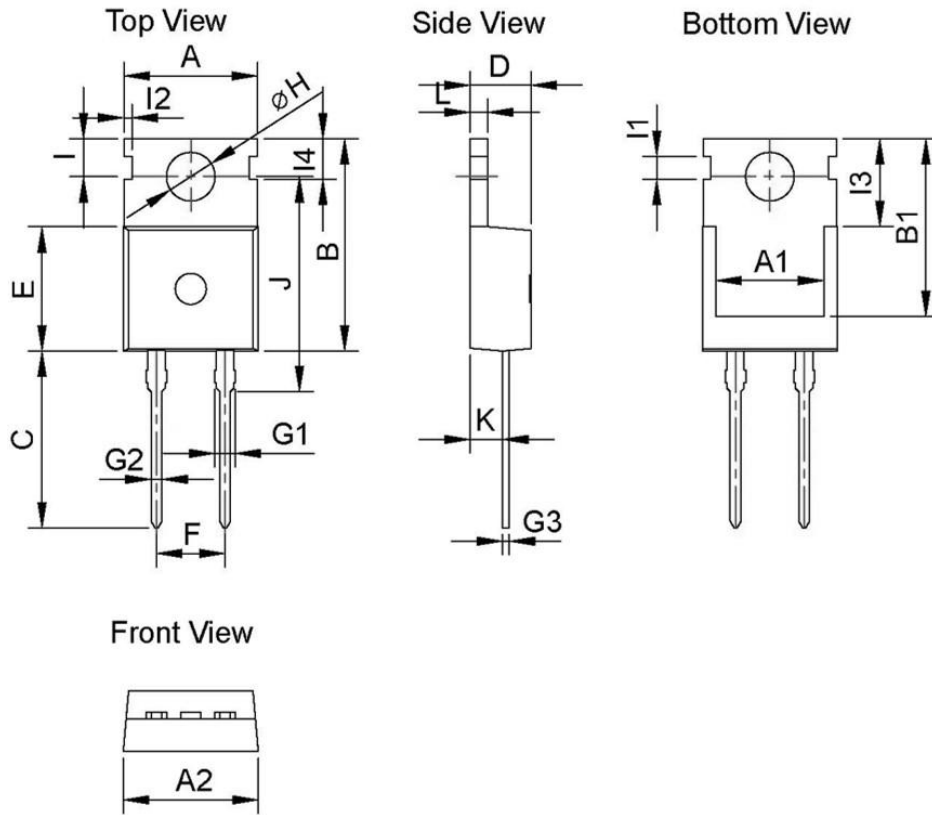

Figure 8. Transient Thermal Impedance
(Junction - Case)

Package Information



Dimension unit: [mm]			
Symbol	Min	Nom	Max
A	9.66	9.90	10.28
A1	6.90	-	-
A2	9.80	10.00	10.20
B	15.60	15.70	15.80
B1	13.16 REF		
C	12.70	13.08	14.27
D	4.30	4.50	4.70
E	8.59	9.20	9.40
F	5.08 BSC		
G1	1.32	1.52	1.62
G2	0.70	0.80	0.95
G3	0.45	0.50	0.60
ϕH	3.53	3.60	3.70
I	2.70	2.80	2.90
I1	1.70 REF		
I2	0.59 REF		
I3	6.50 REF		
I4	3.00 REF		
J	15.70	15.90	16.25
K	2.20	2.40	2.60
L	1.15	1.30	1.40

Recommended Solder Pad Layout

Note: All dimensions are in mm

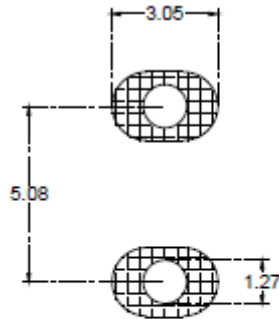

TO-220-2L

Ordering Information

Part number	ASA010V065A4
Package	TO-220-2L
Unit quantity	1000 EA
Packing type	Tube